

Ruijie Reyee RG-RAP1201

Access Point

Hardware Installation and Reference Guide

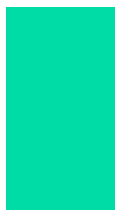
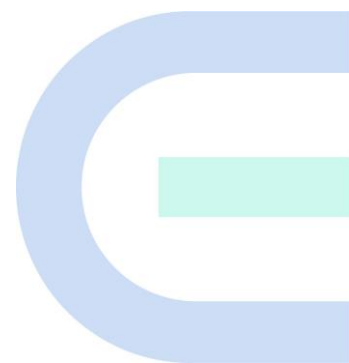

Copyright

Copyright © 2023 Ruijie Networks

All rights are reserved in this document and this statement.

Any reproduction, excerption, backup, modification, transmission, translation or commercial use of this document or any portion of this document, in any form or by any means, without the prior written consent of Ruijie Networks is prohibited.

Trademarks including  are owned by Ruijie Networks.

All other trademarks or registered trademarks mentioned in this document are owned by their respective owners.

Disclaimer

The products, services, or features you purchase are subject to commercial contracts and terms. Some or all of the products, services or features described in this document may not be within the scope of your purchase or use. Unless otherwise agreed in the contract, Ruijie Networks does not make any express or implied statement or guarantee for the content of this document.

Due to product version upgrades or other reasons, the content of this document will be updated from time to time. Ruijie Networks reserves the right to modify the content of the document without any notice or prompt.

This manual is for reference only. Ruijie Networks endeavors to ensure content accuracy and will not shoulder any responsibility for losses and damages caused due to content omissions, inaccuracies or errors.

Preface

Audience

This document is intended for:

- Network engineers
- Technical support and servicing engineers
- Network administrators

Technical Support

- Official website of Ruijie Reye: <https://www.ruijienetworks.com/products/reyee>
- Technical support website: <https://ruijienetworks.com/support>
- Case portal: <https://caseportal.ruijienetworks.com>
- Community: <https://community.ruijienetworks.com>
- Technical support email: service_rj@ruijienetworks.com

Conventions

1. GUI Symbols

Interface symbol	Description	Example
Boldface	1. Button names 2. Window names, tab name, field name and menu items 3. Link	1. Click OK . 2. Select Config Wizard . 3. Click the Download File link.
>	Multi-level menus items	Select System > Time .

2. Signs

The signs used in this document are described as follows:

Warning

An alert that calls attention to important rules and information that if not understood or followed can result in data loss or equipment damage.

 **Caution**

An alert that calls attention to essential information that if not understood or followed can result in function failure or performance degradation.

 **Note**

An alert that contains additional or supplementary information that if not understood or followed will not lead to serious consequences.

 **Specification**

An alert that contains a description of product or version support.

3. Note

This document provides the installation steps, troubleshooting, technical specifications, as well as the specifications and use guidelines of cables and connectors. It is intended for users who want to understand the above contents, and are familiar with the installation and maintenance of networking hardware.

Contents

Preface.....	I
1 Product Overview	1
1.1 Package Contents.....	1
1.2 Product Appearance	2
1.2.1 Front Panel.....	2
1.2.2 Rear Panel	3
1.3 Technical Specifications	4
1.4 Power Module Technical Specifications	6
1.5 Cooling	6
2 Preparing for Installation.....	7
2.1 Safety Precautions.....	7
2.2 Installation Environment Requirements	7
2.2.1 Temperature/Humidity.....	7
2.2.2 Cleanliness	8
2.2.3 ESD Protection.....	9
2.2.4 Anti-interference	9
2.2.5 Mounting Workbench	10
2.3 Tools	10
3 Installing the AP.....	11
3.1 Before You Begin.....	11

3.2 Safety Precautions.....	11
3.3 Installing the AP	12
3.4 Bundling Cables.....	13
3.5 Verifying Installation.....	13
4 Verifying the Operating Status.....	15
4.1 Setting up the Environment	15
4.2 Powering on the AP.....	15
4.2.1 Checking Before Power-On	15
4.2.2 Checking After Power-on.....	15
4.3 Troubleshooting Power Failures.....	15
5 Monitoring and Maintenance.....	16
5.1 Monitoring	16
5.2 Hardware Maintenance	16
6 Troubleshooting	17
6.1 Troubleshooting Flowchart	17
6.2 Common Faults	17
6.2.1 The LED Is Off After the Device is Powered On	17
6.2.2 Ethernet Port Is Not Working After the Ethernet Cable Is Plugged In	17
6.2.3 A STA Cannot Discover the AP.....	18
7 Appendix	19
7.1 Connectors and Media.....	19

7.2 List of Hazardous Substances (10 Years).....20

1 Product Overview

1.1 Package Contents

Table 1-1 Package Contents

No.	Item	Quantity
1	RG-RAP1201 access point	1
2	Protective cover	1
3	Phillips pan head screws (M4 x 20 mm)	2
4	Quick installation guide	1
5	Warranty manual	1

Note

The package contents above are intended to provide a general overview, and are subject to the terms of the order contract. Please check your goods carefully against the package contents or order contract. If you have any questions, please contact the distributor.

1.2 Product Appearance

1.2.1 Front Panel

Figure 1-1 Front Panel

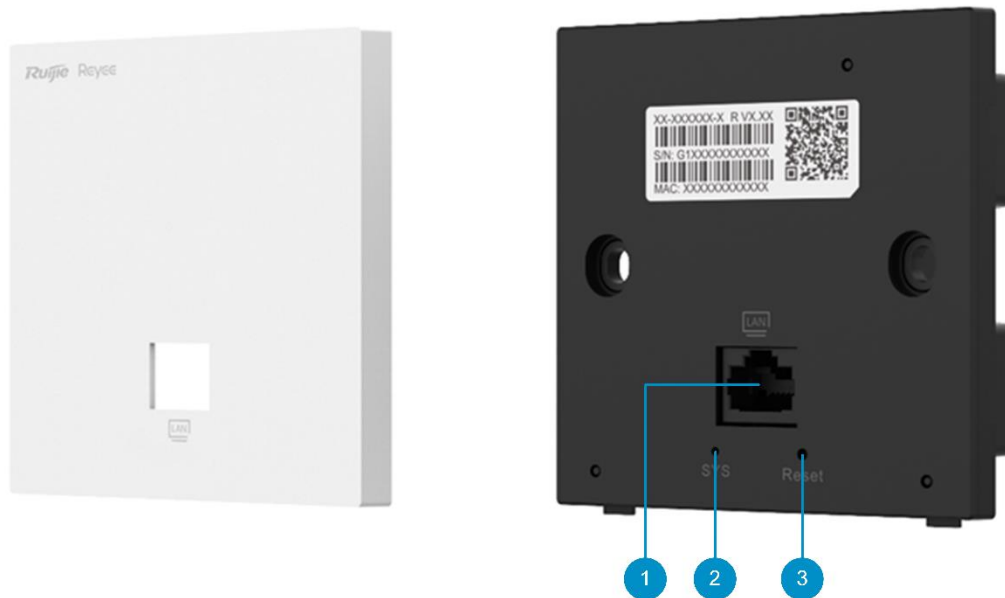

Table 1-2 LEDs

Mark	Item	Status	Description
2	LED	Off	The access point is NOT receiving power.
		Fast blinking (blinks eight times per second)	The access point is starting up.
		Steady white	The access point is functioning properly.
		Slow blinking (blinks twice per second)	The access point is not connected to the Internet.
		Blinks twice consecutively	The access point is upgrading. Do not power it off.

Table 1-3 Ports and Buttons on the Front Panel

Mark	Item	Description
1	LAN port	10/100/1000 Base-T Ethernet port for wired connection
3	Reset hole	<ul style="list-style-type: none"> ● Stick the pin to the Reset hole: Restart the access point. ● Press and hold the pin to the Reset hole for more than 5 seconds: Restore the access point to factory settings.

1.2.2 Rear Panel

Figure 1-2 Rear Panel



Table 1-4 Ports on the Rear Panel

Mark	Port	Description
1	WAN/PoE port	10/100/1000 Base-T Ethernet port for wired Ethernet connection to transmit both data and power

1.3 Technical Specifications

Table 1-5 Specifications

Radio Design	2.4 GHz and 5 GHz dual-radio dual-stream
Protocol and Standard	Supports both 802.11ac wave2/wave1 and 802.11a/b/g/n standards for simultaneous operation
Operating Band	802.11b/g/n: 2.4 GHz-2.4835 GHz 802.11a/n/ac: 5.150 GHz-5.350 GHz, 5.470 GHz-5.725 GHz, 5.725 GHz-5.850 GHz
Antenna	Built-in omni-directional onboard antenna designed for low radiation emissions (2.4 GHz: 3.82 dBi; 5 GHz: 4.10 dBi) Note The peak gain mentioned above refers to the gain of a single antenna.
Spatial Streams	2.4 GHz: 2x2 MIMO 5 GHz: 2x2 MIMO
Data Rate	2.4 GHz: 400 Mbps 5 GHz: 867 Mbps Combined: 1267 Mbps
Modulation	DBPSK/DQPSK/CCK(DSSS)/BPSK/QPSK/16QAM/64QAM/256QAM
Receive Sensitivity	802.11b: -91 dBm (1 Mbps), -88 dBm (5 Mbps), and -85 dBm (11 Mbps) 802.11a/g: -89 dBm (6 Mbps), -80 dBm (24 Mbps), -76 dBm (36 Mbps), and -71 dBm (54 Mbps) 802.11n: -83 dBm (MCS 0), -65 dBm (MCS 7), -83 dBm (MCS 8), and -65 dBm (MCS 15) 802.11ac: HT20: -83 dBm (MCS 0), and -57dBm (MCS 9) 802.11ac: HT40: -79 dBm (MCS 0), and -57 dBm (MCS 9)

	802.11ac: HT80: -76 dBm (MCS 0), and -51dBm (MCS 9)
Max. Transmit Power	<p>2.4 GHz ≤ 20 dBm</p> <p>5 GHz ≤ 30 dBm</p> <hr/> <p> Note</p> <p>The transmitted power may vary based on local laws and regulations.</p> <hr/>
Power Increment	1 dBm
Dimensions (W × D × H)	86 mm x 86 mm x 42.4 mm (9.06 in. x 9.06 in. x 1.93 in., excluding the mounting bracket)
Weight	AP weight: 0.14 kg
Service Ports	<p>Front: 1 x 10/100/1000Base-T Ethernet downlink port</p> <p>Rear: 1 x 10/100/1000Base-T Ethernet uplink port, powered by the power sourcing equipment (PSE)</p>
Management Port	N/A
Status LED	1 x system status LED
Input Power Supply	802.3at/bt-compliant PoE
Max. Power Consumption	≤ 9 W
Bluetooth 5.0	Not supported
Environment	Operating temperature: 0°C to 40°C (32°F to 113°F)
	Storage temperature: -40°C to +70°C (-40°F to +158°F)
	Operating humidity: 5% to 95% (non-condensing)
	Storage humidity: 5% to 95% (non-condensing)

Installation	In-wall mounting
Compliance	CE
MTBF	> 400000 hrs

1.4 Power Module Technical Specifications

The RG-RAP1201 wall-plate wireless access point is compatible with PoE (Power over Ethernet) standards 802.3at and 802.3bt. To power this access point using PoE, make sure that the PSE supports IEEE 802.3af power supply. This ensures that the access point can operate at its full performance potential.

1.5 Cooling

This access point features a fanless design, and can be mounted in an 86 mm junction box on the wall.

2 Preparing for Installation

2.1 Safety Precautions

Note

- To avoid personal injury and device damage, carefully read the safety precautions before you install the device.
 - The following safety precautions may not cover all possible dangers.
-

The RG-RAP1201 wall plate wireless access point plays a vital role in connecting networks, and its proper functioning is crucial for ensuring the normal operation of all interconnected sub-networks.

The following safety precautions must be followed during installation and use.

- Do not place the device in a damp or wet place, and keep the device away from any kind of liquid.
- Install the device in a position far away from any heat sources.
- Wear an ESD wrist strap during installation and maintenance.
- Do not wear loose clothing and tighten your belt, scarf, and sleeves to prevent them from getting caught on the device.
- Keep tools and accessories away from walking areas.
- Use an uninterruptible power source (UPS) to avoid power failures and disturbance.

2.2 Installation Environment Requirements

The RG-RAP1201 wall plate wireless access point must be installed indoors to ensure its normal operation and prolonged service life. The installation site must meet the following requirements.

2.2.1 Temperature/Humidity

You are advised to maintain an appropriate temperature and humidity at the installation site to ensure normal operation and prolonged service life of the device. High humidity can lead to poor insulation and electrical performance issues such as leakage. On the

other hand, low humidity can cause shrinkage of insulation gaskets and looseness of fastening screws, which can generate static electricity and pose a risk to internal circuits, especially in dry climate environments. High temperature can significantly impact the reliability and service life of the device by accelerating the aging process of insulation materials. See the following table for temperature and humidity requirements.

Table 2-1 Temperature/Humidity Requirements

Temperature	Humidity
0°C to 40°C (32°F to 104°F)	5% to 95% (non-condensing)

2.2.2 Cleanliness

Dust poses a significant risk to the operational safety of the device. When indoor dust accumulates on the device, it can lead to electrostatic adsorption and result in poor contact. This not only affects the lifespan of the device, but also increases the likelihood of communication failures. The risk of electrostatic adsorption increases when the indoor relative humidity is low.

The following table describes the requirements for the dust content and granularity.

Table 2-2 Requirements for Dust

Max. diameter (µm)	0.5	1	3	5
Max. concentration (number of particles/m ³)	1.4×10 ⁷	7×10 ⁵	2.4×10 ⁵	1.3×10 ⁵

In addition to dust, the device also has specific requirements on the presence of harmful gases such as hydrochloric acid sulfides in the air at the installation site. These gases can cause accelerated corrosion of metals and aging of certain components. The table below displays the specific limits for harmful gases including SO₂, H₂S, NO₂, NH₃, and Cl₂ at the installation site.

Table 2-3 Requirements for Gases

Gas	Avg. (mg/m ³)	Max. (mg/m ³)
Sulfur dioxide (SO ₂)	0.2	1.5
Hydrogen sulfide (H ₂ S)	0.006	0.03
Nitrogen dioxide (NO ₂)	0.04	0.15
Ammonia gas (NH ₃)	0.05	0.15
Chlorine gas (Cl ₂)	0.01	0.3

2.2.3 ESD Protection

The RG-RAP1201 wall plate wireless access point has been designed with rigorous anti-static procedures during circuit design. However, excessive static electricity can still cause damage to its circuit board. Static electricity in the communication network connected to the access point mainly originates from two sources:

- Outdoor high-voltage transmission lines, lightning and other external electric fields; and
- Internal systems such as indoor flooring materials and overall structure of the access point.

To prevent damage caused by static electricity, please pay attention to the following:

- Keep the indoor installation environment clean and free of dust.
- Maintain appropriate temperature and humidity.

2.2.4 Anti-interference

Anti-interference measures primarily target electromagnetic and current interferences. The following requirements should be considered to ensure effective mitigation of interference:

- Take interference prevention measures for the power supply system.
- Keep the device away from the grounding facility or lightning and grounding facility of the power device as much as possible.
- Keep the device far away from high-frequency current devices such as high-power

radio transmitting stations and radar launchers.

2.2.5 Mounting Workbench

When installing the device on a wall, the following conditions must be met:

- The wall surface must be smooth and clean.
- The network cables must be in good condition.

2.3 Tools

Table 2-4 Tools

Common tools	Phillips screwdriver, cables, fastening bolts, diagonal plier, and cable ties
Special tools	Wire stripper, crimping plier, RJ45 crimping plier, and wire cutter
Meters	Multimeter and bit error rate tester (BERT)

Note

The RG-RAP1201 is not shipped with a tool kit. You need to prepare a tool kit by yourself.

3 Installing the AP

⚠ Caution

Before installing the AP, make sure that you have carefully read the requirements described in Chapter 2.

3.1 Before You Begin

Carefully plan and arrange the installation location, networking mode, power supply, and cabling before installation. Confirm the following requirements before installation:

- The installation location should meet the temperature and humidity requirements of the device.
- The installation location should meet the voltage and current requirements of the device.
- The selected power supply should meet the system power requirements of the device.
- The installation location should meet the network cable requirements of the device.
- The installation location should meet the installation site requirements of the device.
- Ensure that all the specific requirements of the intended users are met if this device is designed for special purpose.

3.2 Safety Precautions

To ensure the normal operation and prolonged service life of the device, the following safety precautions must be followed:

- Do not power on the device during installation.
- Place the device in a well-ventilated environment.
- Do not expose the device to high temperature.
- Keep the device away from high-voltage power cables.
- Install the device indoors.
- Do not expose the device in a thunderstorm or strong electric field.

- Keep the device clean and dust-free.
- Cut off the power before cleaning the device.
- Do not wipe the device with a damp cloth.
- Do not wash the device with liquid.
- Do not open the enclosure when the device is working.
- Fasten the device tightly.

3.3 Installing the AP

(1) Remove the protective cover of an 86 mm junction box.

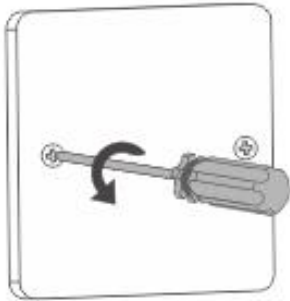

(2) Insert the network cable into the WAN/PoE port on the rear of the device.

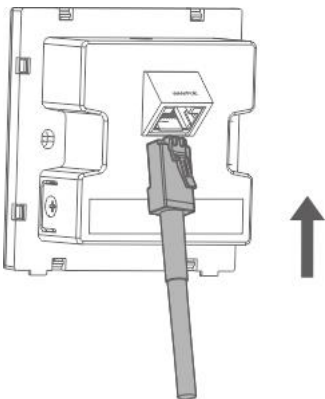

(3) Place the device in the 86 mm junction box, and tighten it with Philips head screws.

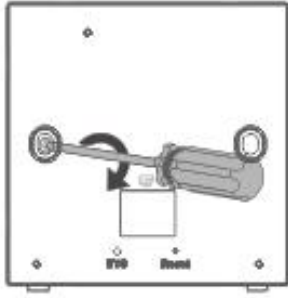

(4) Install the protective cover on the device. The installation process is complete.

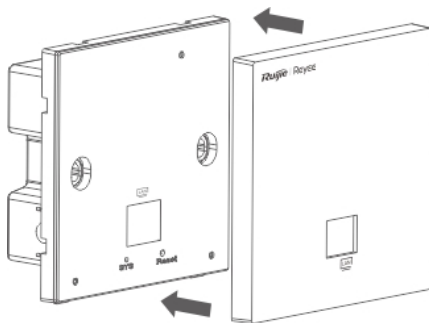

3.4 Bundling Cables

Precautions

- Bundle the cables in a visually pleasing way.
- Bend twisted pairs naturally or to a large radius close to the connector.
- Do not over tighten twisted pair bundle as it may reduce the cable life and performance.

Bundling Procedure

- (1) Bundle the hanging part of the twisted pairs using cable ties, and route them conveniently to the WAN/PoE port of the device.
- (2) Fasten the twisted pair cables to the cable trough of the mounting bracket.
- (3) Extend the twisted pair cables under the device and route them in a straight line.

3.5 Verifying Installation

- Verify that the device is firmly and reliably secured.

- Verify that the twisted pair cable matches the port type.
- Verify that cables are properly bundled.
- Verify that the PSE device is 802.3af-compliant.

4 Verifying the Operating Status

4.1 Setting up the Environment

When powering the device through PoE (Power over Ethernet), ensure that the power cord is properly connected and meets safety requirements.

4.2 Powering on the AP

4.2.1 Checking Before Power-On

Verify that the PSE device connected to the WAN/PoE port of the device is 802.3af-compliant.

4.2.2 Checking After Power-on

- Verify that the LED status is normal.
- After the device is powered on, verify that the SSID can be successfully connected to by a mobile phone or any other wireless device.

4.3 Troubleshooting Power Failures

The working status of the LED on the device indicates whether the device power system is malfunctioning or not. See [LEDs](#) for the LED statuses. Perform the following checks in the case of any abnormality:

- Verify that the AP is properly powered.
- Verify that the network cable of the device is connected correctly.

Note

If the AP still cannot be powered on after the preceding check, please contact your local distributor or technical support.

5 Monitoring and Maintenance

5.1 Monitoring

You can monitor the device in operation by observing its LED.

5.2 Hardware Maintenance

If the hardware is faulty, please contact Ruijie Networks technical support.

6 Troubleshooting

6.1 Troubleshooting Flowchart

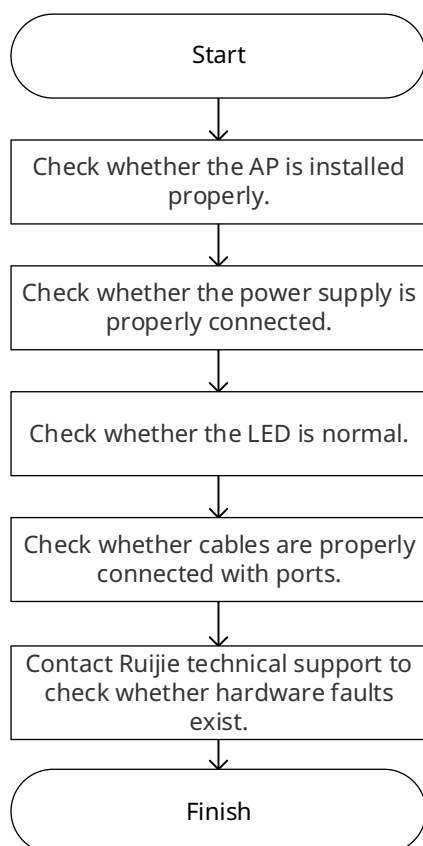

6.2 Common Faults

6.2.1 The LED Is Off After the Device is Powered On

Check whether the PSE connected to the WAN/ PoE port is 802.3af-compliant, and whether the Ethernet cable is connected properly.

6.2.2 Ethernet Port Is Not Working After the Ethernet Cable Is Plugged In

Check whether the PSE connected to the WAN/ PoE port is working properly, and whether the Ethernet cable is capable of providing the required data rate and is properly connected.

6.2.3 A STA Cannot Discover the AP

- (1) Verify that the AP is properly powered.
- (2) Verify that the Ethernet port is correctly connected.
- (3) Verify that the AP is correctly configured.
- (4) Move the client closer to the AP.

7 Appendix

7.1 Connectors and Media

1000BASE-T/100BASE-TX/10BASE-T port

The 1000BASE-T/100BASE-TX/10BASE-T is a 10/100/1000 Mbps auto-negotiation port that supports auto MDI/MDIX Crossover.

Compliant with IEEE 802.3ab, 1000BASE-T requires Category 5e 100-ohm UTP or STP (recommended) with a maximum distance of 100 meters (328 feet).

The 1000BASE-T port requires all four pairs of wires to be connected for data transmission. The following figure shows the four pairs of wires for the 1000BASE-T port.

Figure 7-1 1000BASE-T Twisted Pair Connections

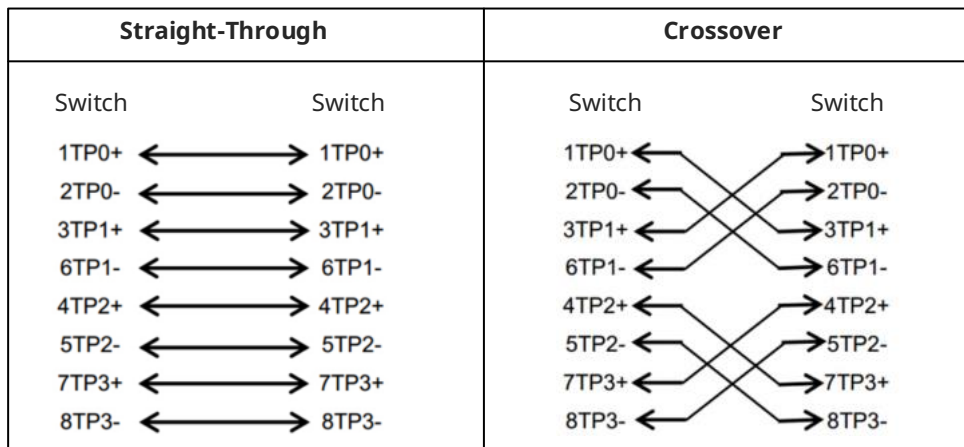

100BASE-TX/10BASE-T can be interconnected using cables of the preceding specifications. For 10 Mbps, the 100BASE-TX/10BASE-T port can be connected using 100-ohm Category 3, Category 4, and Category 5 cables; for 100 Mbps, the 100BASE-TX/10BASE-T port can be connected using 100-ohm Category 5 cables with a maximum distance of 100 meters (328 feet). The following table shows 100BASE-TX/10BASE-T pin assignments.

Table 7-1 100BASE-TX/10BASE-T Pin Assignments

Pin	Socket	Plug
1	Input Receive Data+	Output Transmit Data+
2	Input Receive Data-	Output Transmit Data-
3	Output Transmit Data+	Input Receive Data+
6	Output Transmit Data-	Input Receive Data-
4, 5, 7, 8	Not Used	Not Used

The following figure shows feasible connections of the straight-through and crossover twisted pairs for a 100BASE-TX/10BASE-T port.

Figure 7-2 100BASE-TX/10BASE-T Twisted Pair Connections

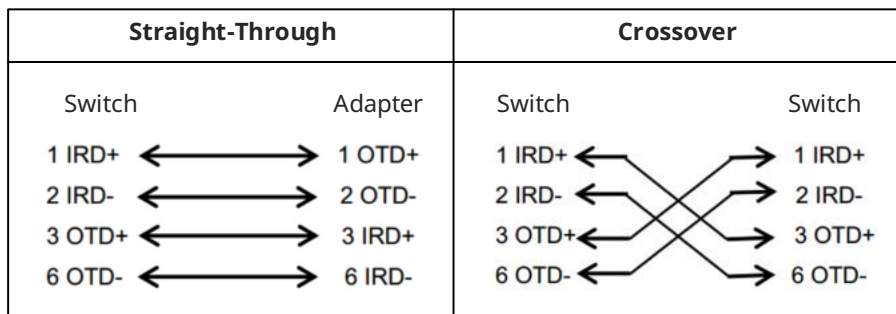

7.2 List of Hazardous Substances (10 Years)

Table 7-2 Name and Content of Hazardous Substances in the Product

Item	Lead	Mercury	Cadmium	Chromium VI	PBB	PBDE
PCB assemblies and components	×	○	○	○	○	○
Other components other than PCB	×	○	○	○	○	○

Cables and cable assemblies	×	○	○	○	○	○
Metal parts	×	○	○	○	○	○
Plastic and polymer parts	×	○	○	○	○	○
Batteries	○	○	○	○	○	○

1. This table is prepared in accordance with SJ/T 11364.

○ : Indicates that the content of this hazardous substance in all homogeneous materials of the component is below the limit specified in GB/T 26572.

×: Indicates that the content of this hazardous substance at least in a certain homogeneous material of the component exceeds the limit specified in GB/T 26572.

2. This table shows the components, in which hazardous substances are found in Ruijie products. Depending on the model, products may not contain all of the above components. The actual model you purchased shall prevail.



3. Unless otherwise marked on the product, the “environmentally friendly service life” of all attached products and their components is indicated by the symbol displayed here. This environmentally friendly service life only applies to the usage conditions specified in the product manual.